

C106 Series

Preferred Device

Sensitive Gate Silicon Controlled Rectifiers

Reverse Blocking Thyristors

Glassivated PNP devices designed for high volume consumer applications such as temperature, light, and speed control; process and remote control, and warning systems where reliability of operation is important.

- Glassivated Surface for Reliability and Uniformity
- Power Rated at Economical Prices
- Practical Level Triggering and Holding Characteristics
- Flat, Rugged, Thermopad Construction for Low Thermal Resistance, High Heat Dissipation and Durability
- Sensitive Gate Triggering
- Device Marking: Device Type, e.g., C106B, Date Code

MAXIMUM RATINGS ($T_J = 25^\circ\text{C}$ unless otherwise noted)

Rating	Symbol	Value	Unit
Peak Repetitive Off-State Voltage ⁽¹⁾ (Sine Wave, 50–60 Hz, $R_{GK} = 1\text{ k}\Omega$, $T_C = -40^\circ$ to 110°C)	V_{DRM} , V_{RRM}		Volts
C106B		200	
C106D, C106D1		400	
C106M, C106M1		600	
On-State RMS Current (180° Conduction Angles, $T_C = 80^\circ\text{C}$)	$I_{T(RMS)}$	4.0	Amps
Average On-State Current (180° Conduction Angles, $T_C = 80^\circ\text{C}$)	$I_{T(AV)}$	2.55	Amps
Peak Non-Repetitive Surge Current (1/2 Cycle, Sine Wave, 60 Hz, $T_J = +110^\circ\text{C}$)	I_{TSM}	20	Amps
Circuit Fusing Considerations ($t = 8.3\text{ ms}$)	I^2t	1.65	A^2s
Forward Peak Gate Power (Pulse Width $\leq 1.0\text{ }\mu\text{sec}$, $T_C = 80^\circ\text{C}$)	P_{GM}	0.5	Watt
Forward Average Gate Power (Pulse Width $\leq 1.0\text{ }\mu\text{sec}$, $T_C = 80^\circ\text{C}$)	$P_{G(AV)}$	0.1	Watt
Forward Peak Gate Current (Pulse Width $\leq 1.0\text{ }\mu\text{sec}$, $T_C = 80^\circ\text{C}$)	I_{GM}	0.2	Amp
Operating Junction Temperature Range	T_J	-40 to +110	$^\circ\text{C}$
Storage Temperature Range	T_{stg}	-40 to +150	$^\circ\text{C}$
Mounting Torque ⁽²⁾	—	6.0	in. lb.

(1) V_{DRM} and V_{RRM} for all types can be applied on a continuous basis. Ratings apply for zero or negative gate voltage; however, positive gate voltage shall not be applied concurrent with negative potential on the anode. Blocking voltages shall not be tested with a constant current source such that the voltage ratings of the devices are exceeded.

(2) Torque rating applies with use of compression washer (B52200F006). Mounting torque in excess of 6 in. lb. does not appreciably lower case-to-sink thermal resistance. Anode lead and heatsink contact pad are common.



ON Semiconductor

<http://onsemi.com>

SCRs
4 AMPERES RMS
200 thru 600 VOLTS

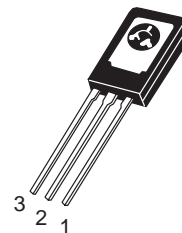

TO-225AA
(formerly TO-126)
CASE 077
STYLE 2

PIN ASSIGNMENT

Pin	Assignment
1	Cathode
2	Anode
3	Gate

ORDERING INFORMATION

Device	Package	Shipping
C106B	TO225AA	500/Box
C106D	TO225AA	500/Box
C106D1	TO225AA	500/Box
C106M	TO225AA	500/Box
C106M1	TO225AA	500/Box

Preferred devices are recommended choices for future use and best overall value.

C106 Series

Thermal Characteristics (T_C = 25°C unless otherwise noted.)

Characteristic	Symbol	Max	Unit
Thermal Resistance, Junction to Case	R _{θJC}	3.0	°C/W
Thermal Resistance, Junction to Ambient	R _{θJA}	75	°C/W
Maximum Lead Temperature for Soldering Purposes 1/8" from Case for 10 Seconds	T _L	260	°C

Electrical Characteristics (T_C = 25°C unless otherwise noted.)

Characteristic	Symbol	Min	Typ	Max	Unit
----------------	--------	-----	-----	-----	------

OFF CHARACTERISTICS

Peak Repetitive Forward or Reverse Blocking Current (V _{AK} = Rated V _{DRM} or V _{RRM} , R _{GK} = 1000 Ohms)	I _{DRM} , I _{RRM}	—	—	10	μA
T _J = 25°C		—	—		
T _J = 110°C		—	—	100	μA

ON CHARACTERISTICS

Peak Forward On-State Voltage ⁽¹⁾ (I _{FM} = 1 A Peak for C106B, D, & M) (I _{FM} = 4 A Peak for C106D1, & M1)	V _{TM}	—	—	2.2	Volts
Gate Trigger Current (Continuous dc) ⁽²⁾ (V _{AK} = 6 Vdc, R _L = 100 Ohms)	I _{GT}	—	15	200	μA
T _J = 25°C		—	35	500	
T _J = -40°C		—			
Peak Reverse Gate Voltage (I _{GR} = 10 μA)	V _{GRM}	—	—	6.0	Volts
Gate Trigger Voltage (Continuous dc) ⁽²⁾ (V _{AK} = 6 Vdc, R _L = 100 Ohms)	V _{GT}	0.4	.60	0.8	Volts
T _J = 25°C		0.5	.75	1.0	
T _J = -40°C					
Gate Non-Trigger Voltage (Continuous dc) ⁽²⁾ (V _{AK} = 12 V, R _L = 100 Ohms, T _J = 110°C)	V _{GD}	0.2	—	—	Volts
Latching Current (V _{AK} = 12 V, I _G = 20 mA)	I _L	—	.20	5.0	mA
T _J = 25°C		—	.35	7.0	
T _J = -40°C		—			
Holding Current (V _D = 12 Vdc) (Initiating Current = 20 mA, Gate Open)	I _H	—	.19	3.0	mA
T _J = 25°C		—	.33	6.0	
T _J = -40°C		—	.07	2.0	
T _J = +110°C		—			

DYNAMIC CHARACTERISTICS

Critical Rate-of-Rise of Off-State Voltage (V _{AK} = Rated V _{DRM} , Exponential Waveform, R _{GK} = 1000 Ohms, T _J = 110°C)	dv/dt	—	8.0	—	V/μs
---	-------	---	-----	---	------

(1) Pulse Test: Pulse Width ≤ 2.0 ms, Duty Cycle ≤ 2%.

(2) R_{GK} is not included in measurement.

C106 Series

Voltage Current Characteristic of SCR

Symbol	Parameter
V_{DRM}	Peak Repetitive Off State Forward Voltage
I_{DRM}	Peak Forward Blocking Current
V_{RRM}	Peak Repetitive Off State Reverse Voltage
I_{RRM}	Peak Reverse Blocking Current
V_{TM}	Peak On State Voltage
I_H	Holding Current

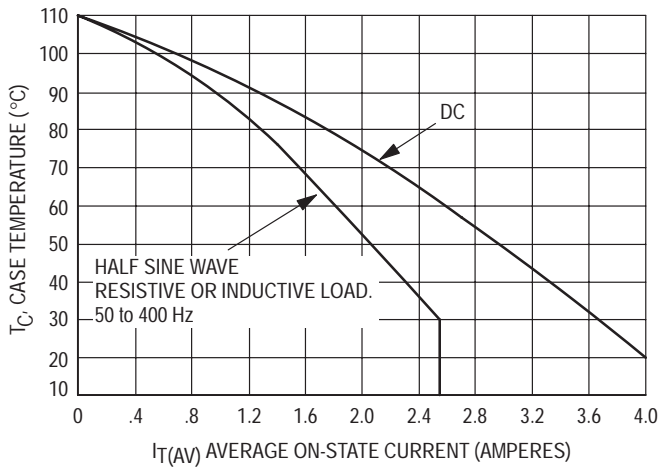
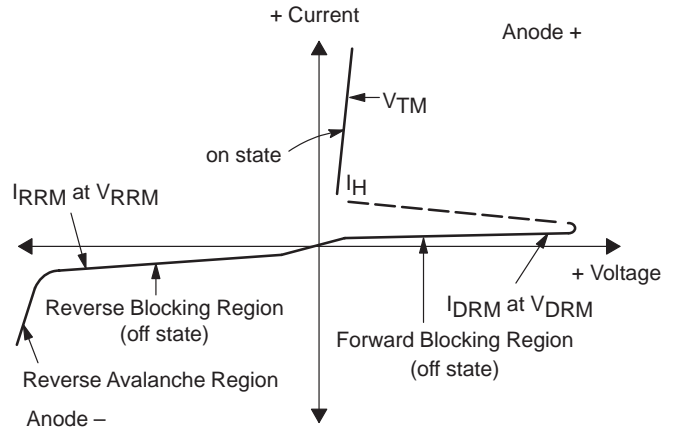

Figure 1. Average Current Derating

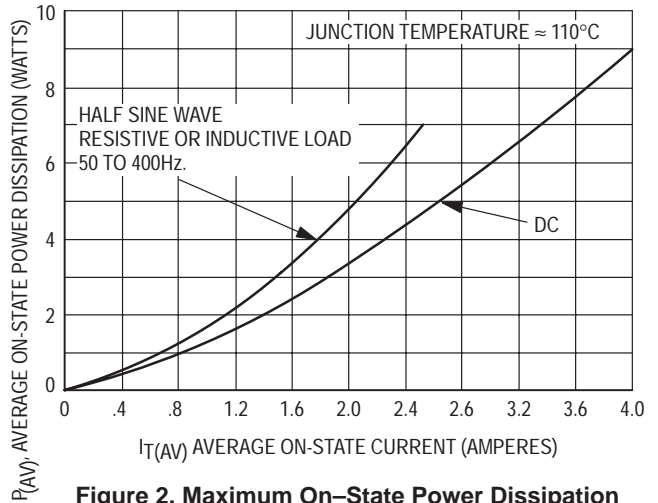

Figure 2. Maximum On-State Power Dissipation

C106 Series

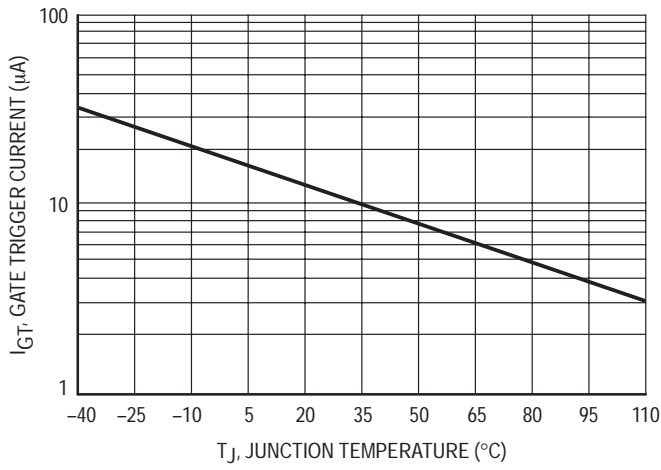

Figure 3. Typical Gate Trigger Current versus Junction Temperature

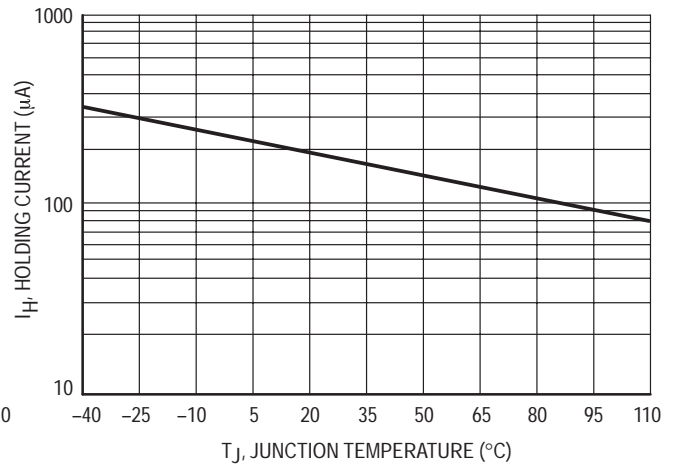

Figure 4. Typical Holding Current versus Junction Temperature

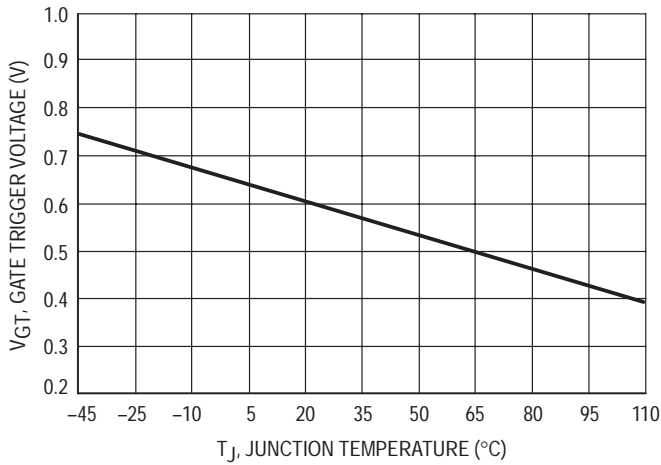

Figure 5. Typical Gate Trigger Voltage versus Junction Temperature

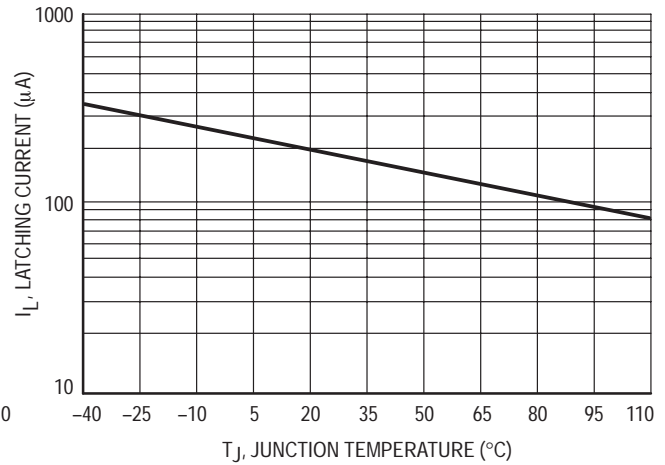
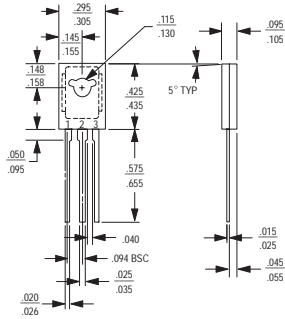

Figure 6. Typical Latching Current versus Junction Temperature

C106 Series

Package Interchangeability

The dimensional diagrams below compare the critical dimensions of the ON Semiconductor C-106 package with competitive devices. It has been demonstrated that the smaller dimensions of the ON Semiconductor package make it compatible in most lead-mount and chassis-mount applications. The user is advised to compare all critical dimensions for mounting compatibility.



ON Semiconductor C-106 Package

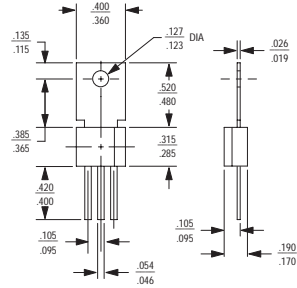

Competitive C-106 Package

C106 Series

PACKAGE DIMENSIONS

TO-225AA
(formerly TO-126)
CASE 077-09
ISSUE W

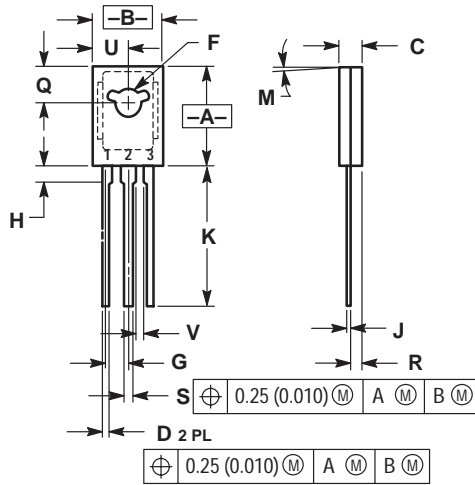

- NOTES:
1. DIMENSIONING AND TOLERANCING PER ANSI Y14.5M, 1982.
2. CONTROLLING DIMENSION: INCH.

DIM	INCHES		MILLIMETERS	
	MIN	MAX	MIN	MAX
A	0.425	0.435	10.80	11.04
B	0.295	0.305	7.50	7.74
C	0.095	0.105	2.42	2.66
D	0.020	0.026	0.51	0.66
F	0.115	0.130	2.93	3.30
G	0.094 BSC		2.39 BSC	
H	0.050	0.095	1.27	2.41
J	0.015	0.025	0.39	0.63
K	0.575	0.655	14.61	16.63
M	5° TYP		5° TYP	
Q	0.148	0.158	3.76	4.01
R	0.045	0.065	1.15	1.65
S	0.025	0.035	0.64	0.88
U	0.145	0.155	3.69	3.93
V	0.040	—	1.02	—

- STYLE 2:
PIN 1. CATHODE
2. ANODE
3. GATE

Notes

C106 Series

ON Semiconductor and  are trademarks of Semiconductor Components Industries, LLC (SCILLC). SCILLC reserves the right to make changes without further notice to any products herein. SCILLC makes no warranty, representation or guarantee regarding the suitability of its products for any particular purpose, nor does SCILLC assume any liability arising out of the application or use of any product or circuit, and specifically disclaims any and all liability, including without limitation special, consequential or incidental damages. "Typical" parameters which may be provided in SCILLC data sheets and/or specifications can and do vary in different applications and actual performance may vary over time. All operating parameters, including "Typicals" must be validated for each customer application by customer's technical experts. SCILLC does not convey any license under its patent rights nor the rights of others. SCILLC products are not designed, intended, or authorized for use as components in systems intended for surgical implant into the body, or other applications intended to support or sustain life, or for any other application in which the failure of the SCILLC product could create a situation where personal injury or death may occur. Should Buyer purchase or use SCILLC products for any such unintended or unauthorized application, Buyer shall indemnify and hold SCILLC and its officers, employees, subsidiaries, affiliates, and distributors harmless against all claims, costs, damages, and expenses, and reasonable attorney fees arising out of, directly or indirectly, any claim of personal injury or death associated with such unintended or unauthorized use, even if such claim alleges that SCILLC was negligent regarding the design or manufacture of the part. SCILLC is an Equal Opportunity/Affirmative Action Employer.

PUBLICATION ORDERING INFORMATION

NORTH AMERICA Literature Fulfillment:

Literature Distribution Center for ON Semiconductor
P.O. Box 5163, Denver, Colorado 80217 USA
Phone: 303-675-2175 or 800-344-3860 Toll Free USA/Canada
Fax: 303-675-2176 or 800-344-3867 Toll Free USA/Canada
Email: ONlit@hibbertco.com
Fax Response Line: 303-675-2167 or 800-344-3810 Toll Free USA/Canada

N. American Technical Support: 800-282-9855 Toll Free USA/Canada

EUROPE: LDC for ON Semiconductor – European Support

German Phone: (+1) 303-308-7140 (M-F 1:00pm to 5:00pm Munich Time)
Email: ONlit-german@hibbertco.com
French Phone: (+1) 303-308-7141 (M-F 1:00pm to 5:00pm Toulouse Time)
Email: ONlit-french@hibbertco.com
English Phone: (+1) 303-308-7142 (M-F 12:00pm to 5:00pm UK Time)
Email: ONlit@hibbertco.com

EUROPEAN TOLL-FREE ACCESS*: 00-800-4422-3781

*Available from Germany, France, Italy, England, Ireland

CENTRAL/SOUTH AMERICA:

Spanish Phone: 303-308-7143 (Mon-Fri 8:00am to 5:00pm MST)
Email: ONlit-spanish@hibbertco.com

ASIA/PACIFIC: LDC for ON Semiconductor – Asia Support

Phone: 303-675-2121 (Tue-Fri 9:00am to 1:00pm, Hong Kong Time)
Toll Free from Hong Kong & Singapore:
001-800-4422-3781
Email: ONlit-asia@hibbertco.com

JAPAN: ON Semiconductor, Japan Customer Focus Center
4-32-1 Nishi-Gotanda, Shinagawa-ku, Tokyo, Japan 141-0031

Phone: 81-3-5740-2745
Email: r14525@onsemi.com

ON Semiconductor Website: <http://onsemi.com>

For additional information, please contact your local Sales Representative.